

**Complete.**

- |                          |                        |
|--------------------------|------------------------|
| ① 75 cm = _____ m        | ② 802 cm = _____ m     |
| ③ 251 km = 251,000 _____ | ④ 0.95 mm = _____ cm   |
| ⑤ 0.46 cm = _____ mm     | ⑥ 32 m = _____ mm      |
| ⑦ 58 mm = _____ m        | ⑧ 2,581 m = _____ km   |
| ⑨ 35.6 mm = _____ cm     | ⑩ 2.92 cm = 29.2 _____ |

**Solve.**

- ⑪ Jason ran 325 meters farther than Kim ran. Kim ran 4.2 kilometers. How many meters did Jason run? Estimate to check your answer.

\_\_\_\_\_

Estimate: \_\_\_\_\_

- ⑫ On each of 3 days, Derrick rode 6.45 km to school, 150 meters to the library, and then 500 meters back home. How many kilometers did he ride for the 3 days altogether?

\_\_\_\_\_

- ⑬ Lisa wants to frame her little brother's drawing as a gift to her mother. The rectangular drawing is 43.5 centimeters by 934 millimeters. How many centimeters of wood framing will she need?

\_\_\_\_\_

- ⑭ Marguerite is building a box from strips of wood. She needs 78 pieces of wood that are each 29 centimeters long. The wood comes in boards that are 6 meters long. How many boards will she need? Explain.

\_\_\_\_\_

\_\_\_\_\_

\_\_\_\_\_

Multiply.

$$\begin{array}{r} 1 \quad 89 \\ \times 7 \\ \hline \end{array}$$

$$\begin{array}{r} 2 \quad 221 \\ \times 3 \\ \hline \end{array}$$

$$\begin{array}{r} 3 \quad 6,077 \\ \times 6 \\ \hline \end{array}$$

$$\begin{array}{r} 4 \quad 77 \\ \times 65 \\ \hline \end{array}$$

Suppose a plant grows at the rate shown in the table.  
Use the table to complete Exercises 5 and 6.

Growth of a Plant	
Age (weeks)	Height (cm)
0	0
1	10
2	20
3	30
4	40

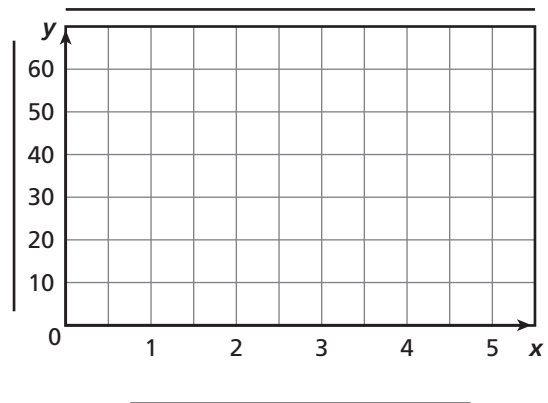

5 Write five ordered pairs that the data represent.

\_\_\_\_\_

6 Graph the ordered pairs. What does each axis of the graph represent? Title the graph and label each axis.

\_\_\_\_\_

\_\_\_\_\_

7 **Stretch Your Thinking** Find the sum of 130 cm and 50 mm in meters. Show your work.

\_\_\_\_\_

\_\_\_\_\_

Complete.

1 36 in. = \_\_\_\_\_ ft

2 12 ft = \_\_\_\_\_ yd

3 36 in. = \_\_\_\_\_ yd

4 \_\_\_\_\_ in. = 4 ft

5 \_\_\_\_\_ ft = 2 yd

6 \_\_\_\_\_ in. = 3 yd

7 \_\_\_\_\_ ft = 90 in.

8 \_\_\_\_\_ in. =  $5\frac{1}{2}$  ft

9 6 yd = \_\_\_\_\_ in.

10 \_\_\_\_\_ yd = 432 in.

11  $1\frac{1}{4}$  yd = \_\_\_\_\_ ft

12 90 ft = \_\_\_\_\_ yd

Find the perimeter of each figure in feet.

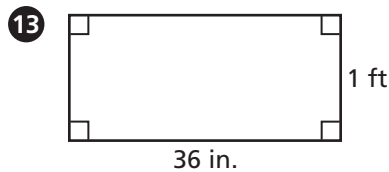

$P = \underline{\hspace{2cm}}$

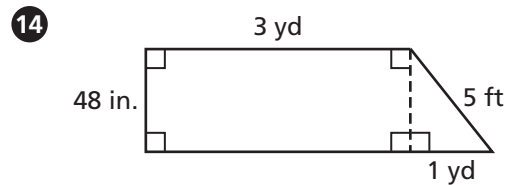

$P = \underline{\hspace{2cm}}$

Find the perimeter of each figure in yards.

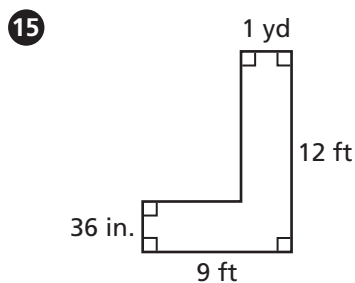

$P = \underline{\hspace{2cm}}$

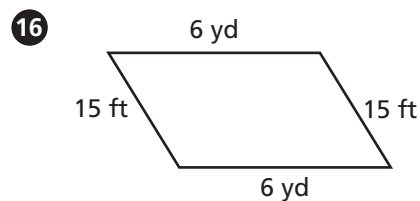

$P = \underline{\hspace{2cm}}$

Write an expression for the words.

- 1 Multiply 12 by the sum of 8 and  $t$ . \_\_\_\_\_
- 2 Divide 10 by 4 and then subtract 6.2. \_\_\_\_\_
- 3 Add the product of 7 and 10 to 80. \_\_\_\_\_
- 4 Subtract  $\frac{1}{8}$  from  $\frac{5}{6}$ . \_\_\_\_\_

Simplify. Follow the Order of Operations.

- 5  $12 - 7 + 9 - 2$
- 6  $15 \div 0.3 + 6 \div 0.02$
- 7  $(2\frac{3}{8} - \frac{1}{4}) \times \frac{1}{5}$
- 8  $\frac{1}{6} \cdot \frac{1}{6} \div \frac{1}{6}$
- 9  $(7.2 - 3.3) \cdot (0.5 + 0.5)$
- 10  $36 \div (6.6 + 2.4) \cdot 4$

Complete the equation.

- 11  $14 \text{ m} = \text{_____ mm}$
- 12  $0.35 \text{ mm} = \text{_____ cm}$
- 13  $790 \text{ cm} = \text{_____ m}$
- 14  $0.88 \text{ cm} = \text{_____ mm}$
- 15  $782 \text{ km} = 782,000 \text{ _____}$
- 16  $58 \text{ cm} = \text{_____ m}$

- 17 **Stretch Your Thinking** Draw a figure composed of three different rectangles that has a perimeter of 140 yards. Use measurements in yards and feet to label the sides of your figure.  
\_\_\_\_\_



Find the perimeter and the area of the rectangle.

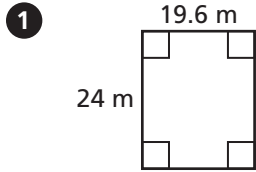

$$P = \underline{\hspace{2cm}}$$

$$A = \underline{\hspace{2cm}}$$

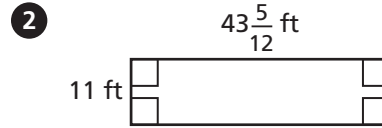

$$P = \underline{\hspace{2cm}}$$

$$A = \underline{\hspace{2cm}}$$

Find the side length of the rectangle.

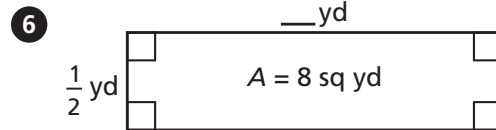
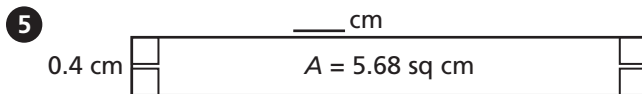
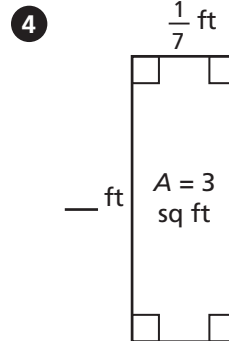
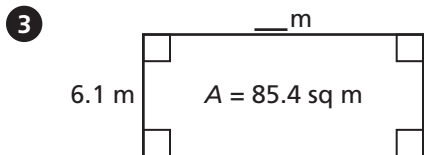

Solve.

- 7 Gerard ran out of tile for his patio. The width of the remaining area is  $2\frac{2}{9}$  feet. The length of the remaining area is 7 feet. How much does Gerard have left to tile?

\_\_\_\_\_

- 8 Kyra is building a dollhouse. The carpet for the bedroom is 27 square inches. The length of the bedroom is 6 inches. How long is the width?

\_\_\_\_\_

The graph shown represents a skier traveling at a constant speed.

- 1 The points on the graph represent four ordered  $(x, y)$  pairs. Write the ordered pairs.  
 (\_\_\_\_, \_\_\_\_) (\_\_\_\_, \_\_\_\_) (\_\_\_\_, \_\_\_\_) (\_\_\_\_, \_\_\_\_)

- 2 Complete the table to show the relationship that time and distance share.

Time (hours)	0			
Distance (miles)	0			

- 3 At what constant rate of speed was the skier traveling? Explain how you know.

---



---



---

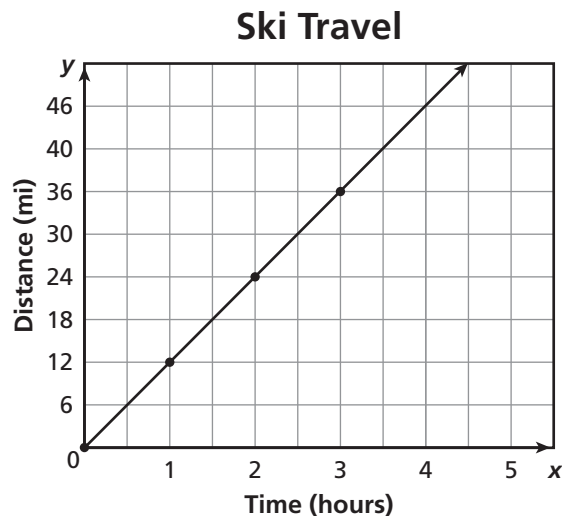

Complete.

- 4 24 in. = \_\_\_\_\_ ft      5 27 ft = \_\_\_\_\_ yd      6 3 ft = \_\_\_\_\_ in.  
 7 \_\_\_\_\_ in. = 5 yd      8 \_\_\_\_\_ yd = 18 ft      9 \_\_\_\_\_ ft = 84 in.  
 10 24 yd = \_\_\_\_\_ ft      11 8 ft = \_\_\_\_\_ in.      12 \_\_\_\_\_ ft = 84 yd

- 13 **Stretch Your Thinking** Find the fractional side lengths of a rectangle that has a perimeter of  $64\frac{5}{6}$  inches. Then find the area of the rectangle.

---

- 1 Alison had a box in the shape of a cube. She decided to use centimeter cubes to find the volume of the box. It took 75 centimeter cubes to fill the box with no gaps. What was the volume of the box?
- \_\_\_\_\_

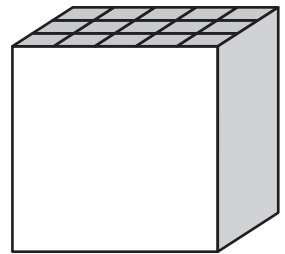

Find the number of unit cubes and the volume.

2

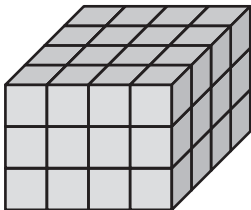

Number of unit cubes: \_\_\_\_\_

Volume: \_\_\_\_\_

3

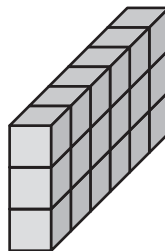

Number of unit cubes: \_\_\_\_\_

Volume: \_\_\_\_\_

4

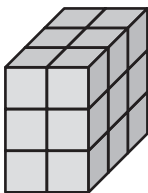

Number of unit cubes: \_\_\_\_\_

Volume: \_\_\_\_\_

5

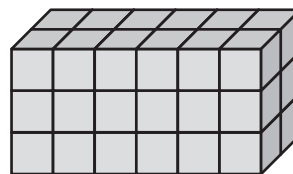

Number of unit cubes: \_\_\_\_\_

Volume: \_\_\_\_\_

6

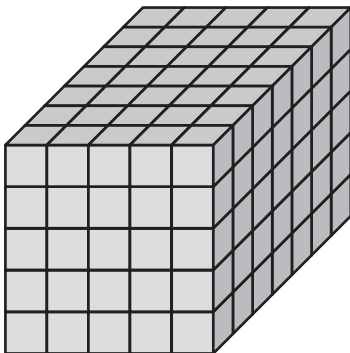

Number of unit cubes: \_\_\_\_\_

Volume: \_\_\_\_\_

7

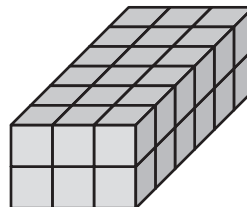

Number of unit cubes: \_\_\_\_\_

Volume: \_\_\_\_\_

Write the computation in words.

1  $4.5 \div 0.5 + 0.1$  \_\_\_\_\_

2  $6 \div \frac{1}{6}$  \_\_\_\_\_

3  $4 \cdot (5 - 2)$  \_\_\_\_\_

4  $11 - c$  \_\_\_\_\_

Find the perimeter and the area of the rectangle.

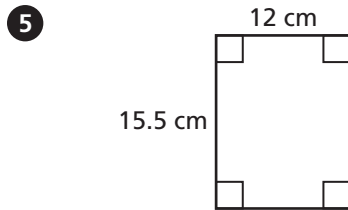

$P =$  \_\_\_\_\_

$A =$  \_\_\_\_\_

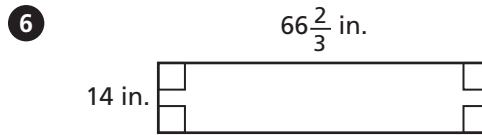

$P =$  \_\_\_\_\_

$A =$  \_\_\_\_\_

- 7 **Stretch Your Thinking** Draw a sketch to show two figures that have the same number of unit cubes that look different from each other.

# 8-5 Homework

Name \_\_\_\_\_

Date \_\_\_\_\_

Use the prism on the right to answer the questions.

- 1 How many cubes are in 1 layer? \_\_\_\_\_
- 2 How many layers are in the prism? \_\_\_\_\_
- 3 Write a multiplication expression for the volume.  
\_\_\_\_\_
- 4 What is the volume of the prism? \_\_\_\_\_

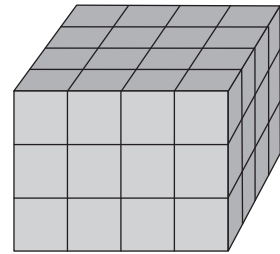

Find the volume.

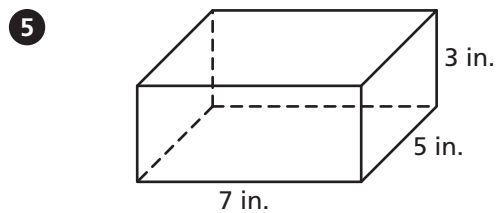

Volume: \_\_\_\_\_

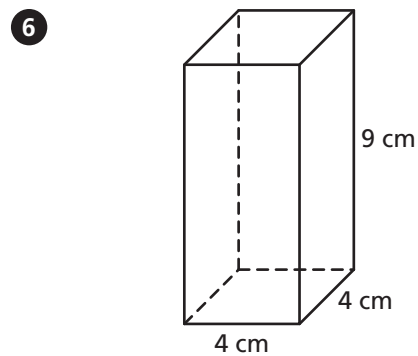

Volume: \_\_\_\_\_

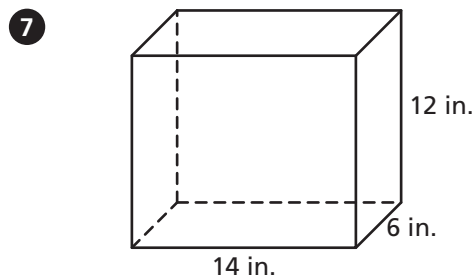

Volume: \_\_\_\_\_

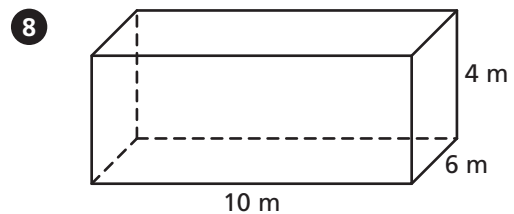

Volume: \_\_\_\_\_

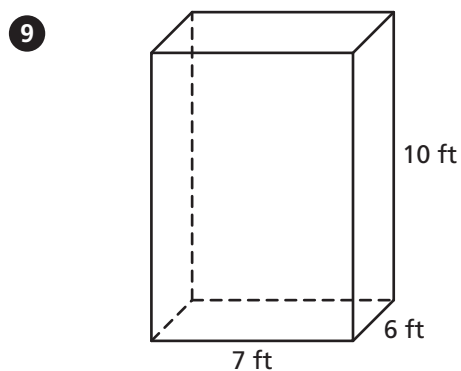

Volume: \_\_\_\_\_

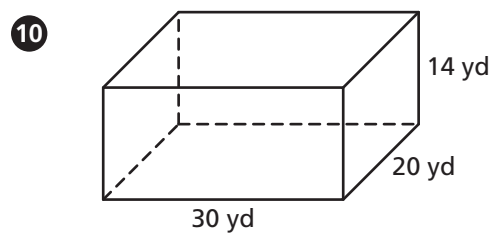

Volume: \_\_\_\_\_

Solve. Follow the Order of Operations.

1  $21 - 6 + 3 - 6$

2  $(7.9 - 5.1) \cdot (0.2 + 0.8)$

3  $6 \cdot 10 \div 5$

4  $\frac{1}{5} \cdot \frac{1}{5} \div \frac{1}{5}$

5  $(2\frac{3}{8} - \frac{1}{4}) \times \frac{1}{8}$

6  $\frac{5}{8} - 3 \cdot \frac{1}{16}$

7  $16 \div 0.2 + 15 \div 0.03$

8  $64 \div (6.6 + 1.4) \cdot 2$

9  $0.7 - 0.9 \div 3 + 0.6$

Find the number of unit cubes and the volume.

10

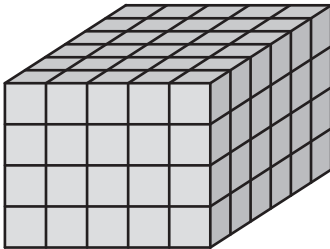

11

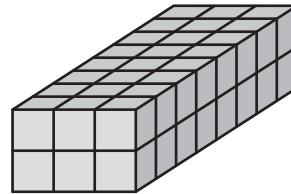

Number of unit cubes: \_\_\_\_\_

Number of unit cubes: \_\_\_\_\_

Volume: \_\_\_\_\_

Volume: \_\_\_\_\_

- 12 **Stretch Your Thinking** I'm a figure with six layers. Each of my layers is the same. My bottom layer has a perimeter of 28 units, and my volume is between 200 and 300 cubic units. What is my volume?

# 8-6 Homework

Name \_\_\_\_\_

Date \_\_\_\_\_

Write a numerical expression for the volume. Then calculate the volume.

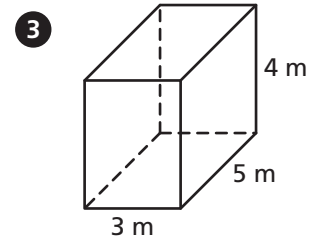
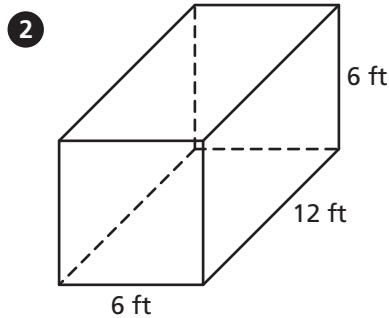
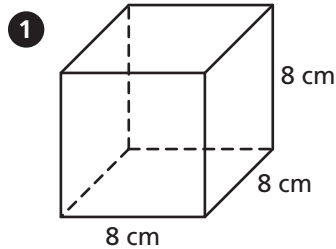

Expression: \_\_\_\_\_

Expression: \_\_\_\_\_

Expression: \_\_\_\_\_

Volume: \_\_\_\_\_

Volume: \_\_\_\_\_

Volume: \_\_\_\_\_

Find the unknown dimension or volume of each rectangular prism.

4  $V = \underline{\hspace{2cm}}$

$l = 4 \text{ cm}$

$w = 4 \text{ cm}$

$h = 11 \text{ cm}$

5  $V = 168 \text{ cu yd}$

$l = \underline{\hspace{2cm}}$

$w = 7 \text{ yd}$

$h = 3 \text{ yd}$

6  $V = 90 \text{ cu in.}$

$l = 9 \text{ in.}$

$w = \underline{\hspace{2cm}}$

$h = 5 \text{ in.}$

Write an equation. Then solve.

- 7 Pattie built a rectangular prism with cubes. The base of her prism has 12 centimeter cubes. If her prism was built with 108 centimeter cubes, how many layers does her prism have?

\_\_\_\_\_

- 8 Isabella cares for an aquarium that is 6 feet long and has a height of 4 feet. The aquarium needs 72 cubic feet of water to be completely filled. What is the width of the aquarium?

\_\_\_\_\_

- 9 Ray's aquarium is 20 inches long, 20 inches wide, and has a height of 15 inches. Randal's aquarium is 40 inches long, 12 inches wide, and has a height of 12 inches. Whose aquarium has a greater volume? By how much?

\_\_\_\_\_

Add or subtract.

1  $0.45 + 0.77 =$  \_\_\_\_\_      2  $0.4 + 0.08 =$  \_\_\_\_\_      3  $6.9 - 3.44 =$  \_\_\_\_\_

4  $7 - 2.2 =$  \_\_\_\_\_      5  $0.66 + 0.96 =$  \_\_\_\_\_      6  $5.7 - 0.9 =$  \_\_\_\_\_

Find the volume.

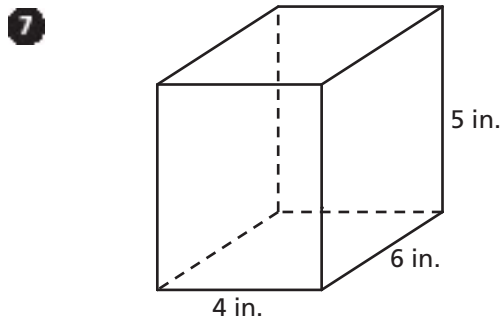

Volume: \_\_\_\_\_

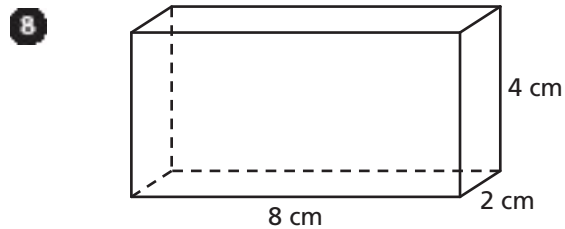

Volume: \_\_\_\_\_

- 9 **Stretch Your Thinking** Give the dimensions of a crate that could be used to ship 6 of the boxes below. Allow for some air space between the boxes so they can fit in the crate.

---



---

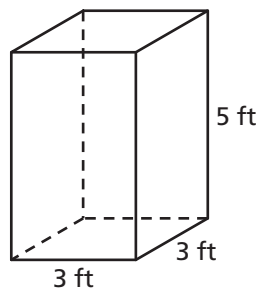



For each question, write whether you would measure for length, area, or volume.

- 1 the amount of space inside a moving van \_\_\_\_\_
- 2 the number of tiles needed to cover a bathroom floor \_\_\_\_\_
- 3 the distance from a porch to a tree \_\_\_\_\_
- 4 the amount of water a tank holds \_\_\_\_\_
- 5 the height of a flagpole \_\_\_\_\_

Solve.

- 6 A box is 5 inches long, 4 inches wide, and 1 inch deep. How much space is inside the box?  
\_\_\_\_\_
- 7 Aponi built a toy chest for her niece. It has a volume of 12 cubic feet. The chest is 3 feet long and 2 feet wide. How deep is it?  
\_\_\_\_\_
- 8 The rug in Alan's room has an area of 18 square feet. He is planning to buy another rug that is twice as long and twice as wide. What is the area of the new rug?  
\_\_\_\_\_
- 9 Each drawer in Monique's nightstand has a volume of 6 cubic decimeters. Each drawer in her dresser is twice as long, twice as wide, and twice as deep. What is the volume of one of Monique's dresser drawers?  
\_\_\_\_\_
- 10 Fong and Daphne built these structures. Who used more cubes? How many more?  
\_\_\_\_\_

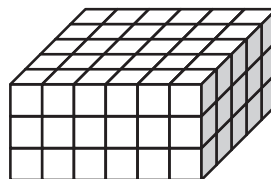

Fong

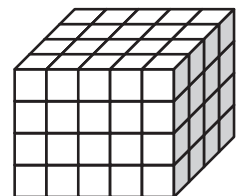

Daphne

Solve.

$$\begin{array}{r} 1 \quad 3.8 \\ \times 5.4 \\ \hline \end{array}$$

$$\begin{array}{r} 2 \quad 0.30 \\ \times 6.7 \\ \hline \end{array}$$

$$\begin{array}{r} 3 \quad 3.3 \\ \times 0.78 \\ \hline \end{array}$$

$$\begin{array}{r} 4 \quad 0.04 \\ \times 7.3 \\ \hline \end{array}$$

$$\begin{array}{r} 5 \quad 0.6 \\ \times 5.14 \\ \hline \end{array}$$

$$\begin{array}{r} 6 \quad 8.3 \\ \times 2.8 \\ \hline \end{array}$$

Find the unknown dimension or volume of each rectangular prism.

$$7 \quad V = \underline{\hspace{2cm}}$$

$$l = 7 \text{ cm}$$

$$w = 4 \text{ cm}$$

$$h = 9 \text{ cm}$$

$$8 \quad V = 200 \text{ cu yd}$$

$$l = \underline{\hspace{2cm}}$$

$$w = 5 \text{ yd}$$

$$h = 5 \text{ yd}$$

$$9 \quad V = 160 \text{ cu in.}$$

$$l = 10 \text{ in.}$$

$$w = \underline{\hspace{2cm}}$$

$$h = 4 \text{ in.}$$

$$10 \quad V = \underline{\hspace{2cm}}$$

$$l = 10 \text{ cm}$$

$$w = 8 \text{ cm}$$

$$h = 6 \text{ cm}$$

$$11 \quad V = 297 \text{ cu m}$$

$$l = \underline{\hspace{2cm}}$$

$$w = 9 \text{ m}$$

$$h = 3 \text{ m}$$

$$12 \quad V = 126 \text{ cu in.}$$

$$l = 9 \text{ in.}$$

$$w = \underline{\hspace{2cm}}$$

$$h = 7 \text{ in.}$$

13 **Stretch Your Thinking** Give one real world example for measuring each of the following: perimeter, area, volume.

---



---



---



---

Find the volume of each composite solid figure.

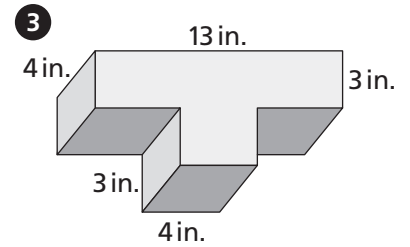
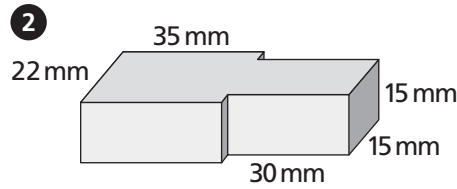
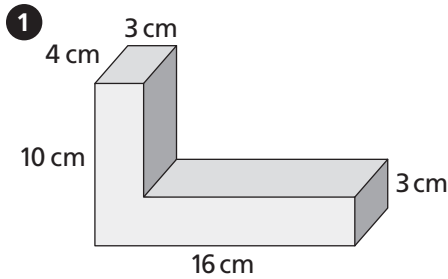

- 4 The exterior of a refrigerator is shaped like a rectangular prism, and measures  $2\frac{2}{3}$  feet wide by  $5\frac{1}{2}$  feet high by  $2\frac{1}{2}$  feet deep. What amount of space does the refrigerator take up?
- \_\_\_\_\_

- 5 In the space below, draw a composite solid of your own design that is made up of two prisms. Write the dimensions of your design, and then calculate its volume.
- \_\_\_\_\_

## Divide

1  $0.7 \overline{)49}$

2  $0.05 \overline{)50}$

3  $0.8 \overline{)0.64}$

4  $0.06 \overline{)36}$

5  $0.3 \overline{)939.6}$

6  $0.06 \overline{)27.3}$

## Solve.

- 7 A fish tank is 20 feet long, 12 feet wide, and 10 feet deep. What is the volume of the fish tank?

---

- 8 **Stretch Your Thinking** Draw a composite solid in the space below using two different rectangular prisms. Label the length and width using fractions of units. The figures do not need to be to scale. Find the volume of the figure.

---

**Complete.**

- |                         |                       |
|-------------------------|-----------------------|
| ① 5,811 mL = _____ L    | ② 297 L = _____ kL    |
| ③ 1.09 kL = 1,090 _____ | ④ 32,500 mL = _____ L |
| ⑤ 53.1 L = _____ mL     | ⑥ 5.66 L = _____ mL   |
| ⑦ 2,848 mL = _____ L    | ⑧ 431 L = _____ kL    |
| ⑨ 0.56 L = _____ mL     | ⑩ 0.78 L = 780 _____  |

**Solve.**

- ⑪ Jennifer made 5 L of punch for her party. Her brother made another 750 mL. If they combine the two batches, how many 180 mL servings would they have? Would there be any punch left over? If so, how much?
- \_\_\_\_\_
- ⑫ On an average day, a horse might drink 50 L, a sheep might drink 4 L, and a chicken might drink 200 mL. How much water would a farm with 3 horses, 15 sheep, and 12 chickens need for a day?
- \_\_\_\_\_
- ⑬ Terrell has a water purifier for backpacking. It will purify 1 liter of water in 1 minute. How long would it take Terrell to purify enough water for 4 canteens that each hold 750 mL, and two that each hold 1.5 L?
- \_\_\_\_\_
- ⑭ The Institute of Medicine determined that a man should drink 3 liters of fluids a day and a woman should drink 2.2 liters. Mr. Morrison drank 880 mL of water at breakfast and Mrs. Morrison drank 700 mL. How much more will they both need to drink combined to meet the recommended amounts for the day?
- \_\_\_\_\_

Suppose the cost of sugar changes at the rate shown in the table. Use the table to complete Exercises 1 and 2.

Cost of Sugar	
Weight (lb)	Cost (\$)
0	\$0
1	\$1.40
2	\$2.80
3	\$4.20
4	\$5.60

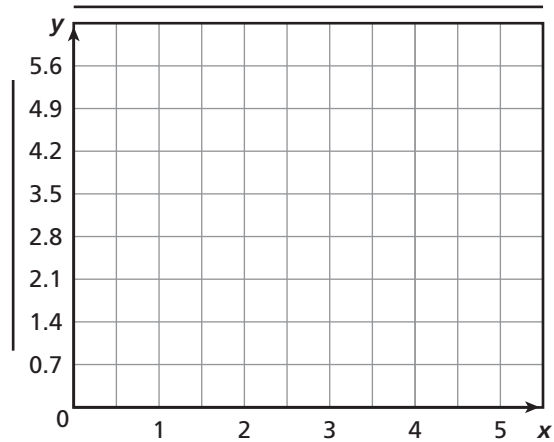

- 1 Write five ordered pairs that the data represent.

\_\_\_\_\_

- 2 Graph the ordered pairs. What does each axis of the graph represent? Title the graph and label each axis.

\_\_\_\_\_

\_\_\_\_\_

Find the volume of each composite solid.

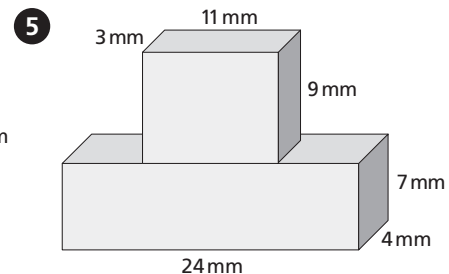
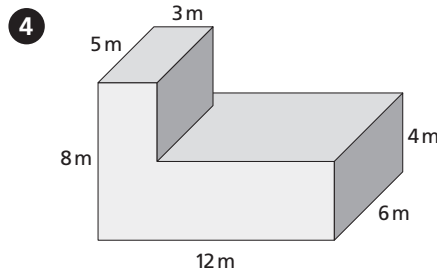
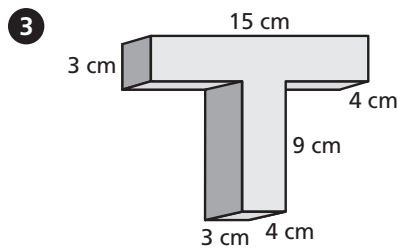

- 6 **Stretch Your Thinking** Shannon pours four different liquid ingredients into a bowl. The sum of the liquid ingredients is 8.53 liters. Two of her measurements are in liters and two of her measurements are in milliliters. Give an example of possible measurements for Shannon's four liquids.

\_\_\_\_\_

# 8-10 Homework

Name \_\_\_\_\_

Date \_\_\_\_\_

Complete.

- 1 973 mg = 0.973 \_\_\_\_\_
- 2 0.058 g = 58 \_\_\_\_\_
- 3 10.64 kg = \_\_\_\_\_ g
- 4 4.001 kg = \_\_\_\_\_ mg
- 5 29 g = 0.029 \_\_\_\_\_
- 6 7 mg = \_\_\_\_\_ g
- 7 3.7 g = \_\_\_\_\_ mg
- 8 84 g = \_\_\_\_\_ kg

Solve.

- 9 The mass of substances left in a sample after the liquid is evaporated is called the *total dissolved solids*. Kim split up 2 liters of water into three different samples and boiled all the liquid away in each. The masses of solids left in the three samples were 2.025 grams, 457 mg, and 589 mg. Using the table at the right, how should Kim classify the water?
- \_\_\_\_\_

Total Dissolved Solids in 1 Liter of Solution	
fresh	< 1,000 mg
brackish	1,000 to 10,000 mg
saline	> 10,000 mg

- 10 Jamal watched his older brother Robert lift weights. The bar alone had a mass of 20 kg. On the bar he had two 11.4 kg weights, two 4.5 kg weights, and four 450 g weights. What mass was Robert lifting?
- \_\_\_\_\_

- 11 Barry bought 25 kg of fish-flavored cat food and 35 kg of chicken-flavored cat food for the cat rescue center. He is going to divide the cat food into packets of 300 grams. How many packets will he make?
- \_\_\_\_\_

Greyson rides his bike at a constant rate. In 30 minutes, Greyson can bike 7 miles.

- 1 Complete the table to show the distance Greyson can ride in 0, 30, 60, and 90 minutes.

Time (min)	0	30	60	90
Distance (mi)		7		

- 2 Write the ordered  $(x, y)$  pairs the data represent. Then graph the points and extend the line.

(\_\_\_\_, \_\_\_\_) (\_\_\_\_, \_\_\_\_) (\_\_\_\_, \_\_\_\_) (\_\_\_\_, \_\_\_\_)

- 3 How far would you expect Greyson to ride in 105 minutes? Explain your answer.

---



---

Biking Distance

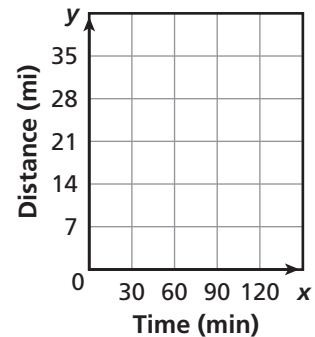

Complete the equation.

4  $435 \text{ L} = \underline{\hspace{2cm}} \text{ kL}$

5  $6.71 \text{ L} = \underline{\hspace{2cm}} \text{ mL}$

6  $86,300 \text{ mL} = \underline{\hspace{2cm}} \text{ L}$

7  $109 \text{ L} = \underline{\hspace{2cm}} \text{ kL}$

8  $5,669 \text{ mL} = \underline{\hspace{2cm}} \text{ L}$

9  $30.8 \text{ L} = \underline{\hspace{2cm}} \text{ mL}$

10  $9.12 \text{ kL} = 9,120 \underline{\hspace{2cm}}$

11  $9,235 \text{ mL} = \underline{\hspace{2cm}} \text{ L}$

- 12 **Stretch Your Thinking** Write three measurements using grams and three measurements using milligrams that total 15.4 grams.

---



---



**8-11**  
**Homework**

Name \_\_\_\_\_

Date \_\_\_\_\_

**Complete.**

1 2 pt = \_\_\_\_\_ qt

2 4 qt = \_\_\_\_\_ gal

3 2 c = \_\_\_\_\_ pt

4 3 qt = \_\_\_\_\_ pt

5 1 qt = \_\_\_\_\_ c

6 5 gal = \_\_\_\_\_ qt

7 \_\_\_\_\_ qt = 52 c

8 \_\_\_\_\_ qt = 46 pt

9 112 c = \_\_\_\_\_ gal

10  $11\frac{1}{2}$  gal = \_\_\_\_\_ qt

11 112 c = \_\_\_\_\_ pt

12 75 pt = \_\_\_\_\_ qt

**Write a fraction.**

13 What fraction of 1 gallon is 1 quart?

14 What fraction of 1 quart is 3 cups?

\_\_\_\_\_

\_\_\_\_\_

15 What fraction of 1 gallon is 5 cups?

16 What fraction of 1 pint is 1 cup?

\_\_\_\_\_

\_\_\_\_\_

**Solve.**

*Show your work.*

17 Cesar bought 2 bottles of juice that each hold 2 quarts and another bottle that holds  $1\frac{1}{2}$  gallons of juice. How many quarts of juice did he buy?

\_\_\_\_\_

18 Samantha saw two bottles of ketchup at the store for the same price. One bottle contained 4 pints of ketchup, and the other contained 1.25 quarts of ketchup. Which bottle was the better bargain?

\_\_\_\_\_

19 A pitcher is full of lemonade. Which unit of liquid volume best describes the amount of lemonade in the pitcher? Explain.

\_\_\_\_\_

\_\_\_\_\_

\_\_\_\_\_

\_\_\_\_\_

Divide.

1  $5 \overline{)2,245}$

2  $6 \overline{)3,277}$

3  $9 \overline{)4,558}$

4  $56 \overline{)1,344}$

5  $47 \overline{)3,619}$

6  $23 \overline{)2,047}$

7  $91 \overline{)4,315}$

8  $62 \overline{)4,030}$

9  $18 \overline{)1,241}$

Complete.

10  $5 \text{ mg} = \underline{\hspace{2cm}} \text{ g}$

11  $13.45 \text{ kg} = \underline{\hspace{2cm}} \text{ g}$

12  $66 \text{ g} = 0.066 \underline{\hspace{2cm}}$

13  $0.021 \text{ g} = 21 \underline{\hspace{2cm}}$

14  $5.003 \text{ kg} = \underline{\hspace{2cm}} \text{ mg}$

15  $782 \text{ mg} = 0.782 \underline{\hspace{2cm}}$

16 **Stretch Your Thinking** What fraction of a gallon is 3 pints?

\_\_\_\_\_

# 8-12 Homework

Name \_\_\_\_\_

Date \_\_\_\_\_

Complete.

1 1 lb = \_\_\_\_\_ oz

2 2 T = \_\_\_\_\_ lb

3 32 oz = \_\_\_\_\_ lb

4 1,000 lb = \_\_\_\_\_ T

5 4 lb = \_\_\_\_\_ oz

6 10,000 lb = \_\_\_\_\_ T

Write a mixed number in simplest form to represent the number of pounds equivalent to each number of ounces.

7 40 oz = \_\_\_\_\_ lb

8 50 oz = \_\_\_\_\_ lb

9 44 oz = \_\_\_\_\_ lb

10 68 oz = \_\_\_\_\_ lb

11 22 oz = \_\_\_\_\_ lb

12 94 oz = \_\_\_\_\_ lb

Solve.

*Show your work.*

- 13 At a garden center, grass seed sells for \$8 per pound. Kalil spent \$10 on grass seed. What amount of seed did he buy?

\_\_\_\_\_

- 14 Two boxes of tea weigh 3 oz. The Tea Time Tasty Tea Company packs 112 boxes in a case of tea. How many pounds does each case of tea weigh?

\_\_\_\_\_

- 15 Juli uses 12 ounces of cheese in her potato soup recipe. Her recipe yields 8 servings. If Juli needs enough for 20 servings, how many pounds of cheese will she need?

\_\_\_\_\_

- 16 At a grocery store, salted peanuts in the shell cost 30¢ per ounce. Is \$5.00 enough money to buy 1 pound of peanuts? If it is, what amount of money will be left over?

\_\_\_\_\_

Complete the pattern.

①  $5 \times 10^1 = 5 \times 10 = \underline{\hspace{2cm}}$

$5 \times 10^2 = 5 \times 100 = \underline{\hspace{2cm}}$

$5 \times 10^3 = 5 \times 1,000 = \underline{\hspace{2cm}}$

$5 \times 10^4 = 5 \times 10,000 = \underline{\hspace{2cm}}$

②  $45 \times 10^1 = \underline{\hspace{2cm}} = 450$

$45 \times 10^2 = \underline{\hspace{2cm}} = 4,500$

$45 \times 10^3 = \underline{\hspace{2cm}} = 45,000$

$45 \times 10^4 = \underline{\hspace{2cm}} = 450,000$

③  $17 \times 10^1 = 17 \times 10 = \underline{\hspace{2cm}}$

$17 \times 10^2 = 17 \times 100 = \underline{\hspace{2cm}}$

$17 \times 10^3 = 17 \times 1,000 = \underline{\hspace{2cm}}$

$17 \times 10^4 = 17 \times 10,000 = \underline{\hspace{2cm}}$

④  $342 \times 10^1 = \underline{\hspace{2cm}} = 3,420$

$342 \times 10^2 = 342 \times 100 = \underline{\hspace{2cm}}$

$342 \times 10^3 = \underline{\hspace{2cm}} = 342,000$

$342 \times 10^4 = 342 \times 10,000 = \underline{\hspace{2cm}}$

Solve.

⑤  $8 \text{ qt} = \underline{\hspace{1cm}} \text{ pt}$

⑥  $2 \text{ qt} = \underline{\hspace{1cm}} \text{ c}$

⑦  $\underline{\hspace{1cm}} \text{ c} = 2 \text{ pt}$

⑧  $80 \text{ cups} = \underline{\hspace{1cm}} \text{ gal}$

⑨  $9\frac{1}{2} \text{ gal} = \underline{\hspace{1cm}} \text{ qt}$

⑩  $80 \text{ cups} = \underline{\hspace{1cm}} \text{ pt}$

⑪  $\underline{\hspace{1cm}} \text{ qt} = 24 \text{ cups}$

⑫  $\underline{\hspace{1cm}} \text{ pt} = 32 \text{ qt}$

⑬  $\underline{\hspace{1cm}} \text{ qt} = 25 \text{ pt}$

- ⑭ **Stretch Your Thinking** Divide 15 pounds of rice into four unequal measures using ounces.

\_\_\_\_\_

- 1 Perry is growing maple saplings. After 3 weeks, he measured the saplings to the nearest quarter inch and drew this line plot with the data. Use the line plot to answer questions about the saplings.

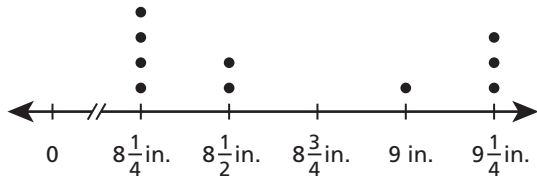

**Heights of the Saplings  
After 3 Weeks**

- a. How many saplings were there?

\_\_\_\_\_

- b. How many saplings were less than 9 inches tall?

\_\_\_\_\_

- c. What is the combined height of all the saplings?

\_\_\_\_\_

- 2 As a volunteer at the animal shelter, Uma weighed all the puppies. She made a list of the weights as she weighed them. The puppies weights were  $3\frac{3}{4}$  lb,  $4\frac{1}{4}$  lb,  $3\frac{1}{2}$  lb,  $3\frac{3}{4}$  lb,  $3\frac{1}{4}$  lb,  $3\frac{3}{4}$  lb,  $3\frac{1}{2}$  lb,  $4\frac{1}{4}$  lb, and  $3\frac{3}{4}$  lb.

- a. Draw a line plot of the puppies' weights.

- b. Use the line plot to write and answer a question about the data.



\_\_\_\_\_

\_\_\_\_\_

\_\_\_\_\_

\_\_\_\_\_

\_\_\_\_\_

Write an equation to solve each problem.

*Show your work.*

- ① At the school bookstore, Harrison purchases 3 notebooks for \$2.50 each, 10 pens for \$0.35 each, and 5 mechanical pencils for \$0.89 each. By what amount ( $a$ ) is the cost of the mechanical pencils greater than the cost of the pens?

\_\_\_\_\_

- ② This week an employee is scheduled to work 6 hours each day Monday through Friday, and  $3\frac{1}{2}$  hours on Saturday morning. If the employee's goal is to work 40 hours, how many additional hours ( $h$ ) must he work?

\_\_\_\_\_

Complete.

- ③ 6 T = \_\_\_\_\_ lb      ④ 3 lb = \_\_\_\_\_ oz      ⑤ \_\_\_\_\_ oz = 5 lb  
 ⑥ 5,000 lb = \_\_\_\_\_ T      ⑦ 8 lb = \_\_\_\_\_ oz      ⑧ 20,000 lb = \_\_\_\_\_ T

Write a mixed number in simplest form to represent the number of pounds equivalent to each number of ounces.

- ⑨ 66 oz = \_\_\_\_\_ lb      ⑩ 52 oz = \_\_\_\_\_ lb      ⑪ 24 oz = \_\_\_\_\_ lb  
 ⑫ 76 oz = \_\_\_\_\_ lb      ⑬ 82 oz = \_\_\_\_\_ lb      ⑭ 46 oz = \_\_\_\_\_ lb

- ⑮ **Stretch Your Thinking** List three different real world situations in which a line plot would be the best choice to organize and display the data.

\_\_\_\_\_

\_\_\_\_\_

\_\_\_\_\_

\_\_\_\_\_

Circle all the names that describe the shape.

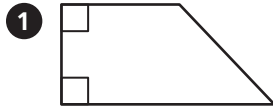

quadrilateral    trapezoid  
 parallelogram    rhombus  
 rectangle        square



quadrilateral    trapezoid  
 parallelogram    rhombus  
 rectangle        square

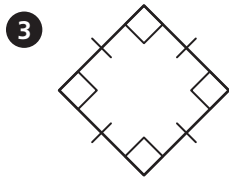

quadrilateral    trapezoid  
 parallelogram    rhombus  
 rectangle        square

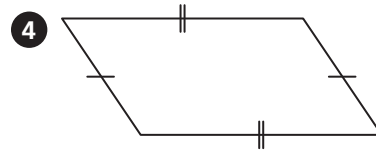

quadrilateral    trapezoid  
 parallelogram    rhombus  
 rectangle        square

Sketch a shape that fits the description, if possible.

5 a trapezoid with two right angles

6 a rhombus with a line of symmetry

7 a parallelogram with a right angle that is not a rectangle

8 a rectangle with opposite sides that are not congruent

Add or subtract.

$$\begin{array}{r} \textcircled{1} \quad \frac{5}{6} \\ - \frac{1}{3} \\ \hline \end{array}$$

$$\begin{array}{r} \textcircled{2} \quad \frac{3}{4} \\ - \frac{5}{8} \\ \hline \end{array}$$

$$\begin{array}{r} \textcircled{3} \quad \frac{1}{6} \\ + \frac{2}{3} \\ \hline \end{array}$$

$$\begin{array}{r} \textcircled{4} \quad \frac{5}{9} \\ + \frac{1}{3} \\ \hline \end{array}$$

$$\begin{array}{r} \textcircled{5} \quad 1\frac{4}{9} \\ + 4\frac{2}{3} \\ \hline \end{array}$$

$$\begin{array}{r} \textcircled{6} \quad 6\frac{4}{5} \\ - 2\frac{1}{10} \\ \hline \end{array}$$

- 7** Dayna surveyed her classmates to find out how many e-mails they send per day. Then, she drew this line plot with the data. Use the line plot to answer questions about the e-mails sent.

- a. How many classmates were surveyed?

\_\_\_\_\_

- b. How many classmates sent fewer than 5 e-mails?

\_\_\_\_\_

- c. How many classmates sent at least 7 e-mails?

\_\_\_\_\_

- 8 Stretch Your Thinking** Explain why a square is always a rectangle but a rectangle is not always a square.

\_\_\_\_\_

\_\_\_\_\_

\_\_\_\_\_

\_\_\_\_\_

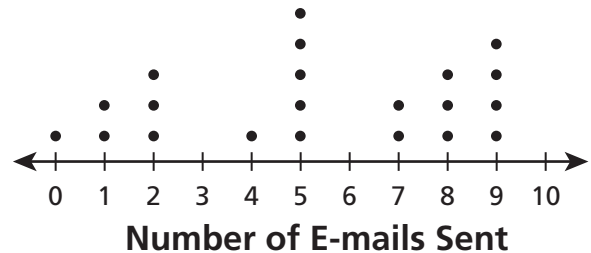



**8-15**  
**Homework**

Name \_\_\_\_\_

Date \_\_\_\_\_

Circle all the names that describe the shape.

**1**

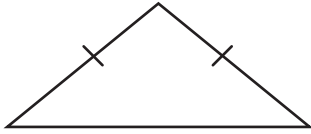

- acute                  scalene
- right                 isosceles
- obtuse                equilateral

**2**

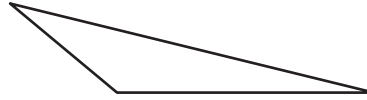

- acute                  scalene
- right                 isosceles
- obtuse                equilateral

**3**

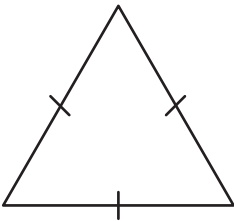

- acute                  scalene
- right                 isosceles
- obtuse                equilateral

**4**

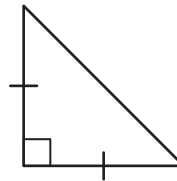

- acute                  scalene
- right                 isosceles
- obtuse                equilateral

Sketch a shape that fits the description, if possible.

**5**

a triangle with two obtuse angles

**6**

a right scalene triangle

**7**

an acute triangle that is not equilateral

**8**

a scalene triangle with a line of symmetry

Solve.

1  $\frac{1}{5} \div 6 =$  \_\_\_\_\_

2  $7 \div \frac{1}{4} =$  \_\_\_\_\_

3  $\frac{6}{7} \cdot \frac{1}{5} =$  \_\_\_\_\_

4  $\frac{1}{10} \div 5 =$  \_\_\_\_\_

5  $4 \cdot \frac{1}{5} =$  \_\_\_\_\_

6  $\frac{1}{3} \cdot 14 =$  \_\_\_\_\_

Find each product by first rewriting each mixed number as a fraction.

7  $\frac{3}{5} \cdot 1\frac{1}{6} =$  \_\_\_\_\_

8  $2\frac{2}{3} \cdot 6 =$  \_\_\_\_\_

9  $4\frac{5}{6} \cdot 2\frac{1}{5} =$  \_\_\_\_\_

10  $4\frac{1}{4} \cdot \frac{3}{8} =$  \_\_\_\_\_

Circle all the names that describe the shape.

11

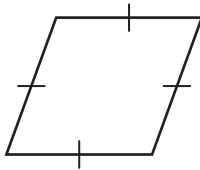

12

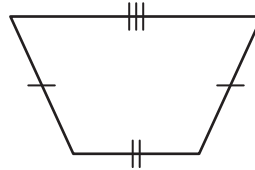

quadrilateral

trapezoid

quadrilateral

trapezoid

parallelogram

rhombus

parallelogram

rhombus

rectangle

square

rectangle

square

- 13 **Stretch Your Thinking** The sum of the lengths of any two sides of a triangle must be greater than the length of the third side. List three side lengths that will form a triangle. Use a ruler and draw the triangle.
-

Draw a shape that fits the description. Mark all congruent segments and right angles.

- 1 an open shape made up of one or more curves
- 2 a concave quadrilateral with an acute angle and exactly two congruent sides
- 3 a closed shape that is not a polygon made entirely of segments
- 4 a convex pentagon with two parallel sides and two perpendicular sides
- 5 a concave hexagon with two pairs of congruent sides
- 6 a quadrilateral with four congruent sides that is not regular

Simplify. Follow the Order of Operations.

1  $61 - 300 \div 6$

2  $0.8 \div (0.09 - 0.07)$

3  $4 \cdot 9 - 12 \div 3$

4  $(\frac{5}{12} + \frac{3}{4}) \cdot 12$

5  $44 + 29 - 13 + 34$

6  $100 \div (6 - 2) \cdot 5$

Circle all the names that describe the shape.

7

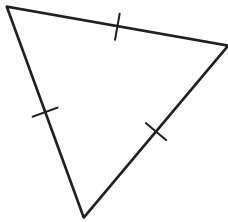

acute    scalene  
right    isosceles  
obtuse    equilateral

8

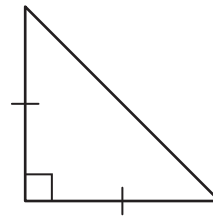

acute    scalene  
right    isosceles  
obtuse    equilateral

- 9 **Stretch Your Thinking** Write a description of a two-dimensional shape and then draw the shape.

\_\_\_\_\_

Solve.

1 On the grid below, draw and label an aquarium shaped like a rectangular prism with a volume of 8,000 cubic inches. (Hint: A cube is a rectangular prism, and  $2 \times 2 \times 2 = 8$ .)

2 Calculate the perimeter of the top of your aquarium. Then calculate the area of its base.

$$P = \underline{\hspace{10em}}$$

$$A = \underline{\hspace{10em}}$$

3 The rectangular prism you drew for Problem 1 is not the only rectangular prism that has a volume of 8,000 cubic inches. Other prisms are possible. On the grid below, use a new color and draw a different rectangular prism that has a volume of 8,000 cubic inches.

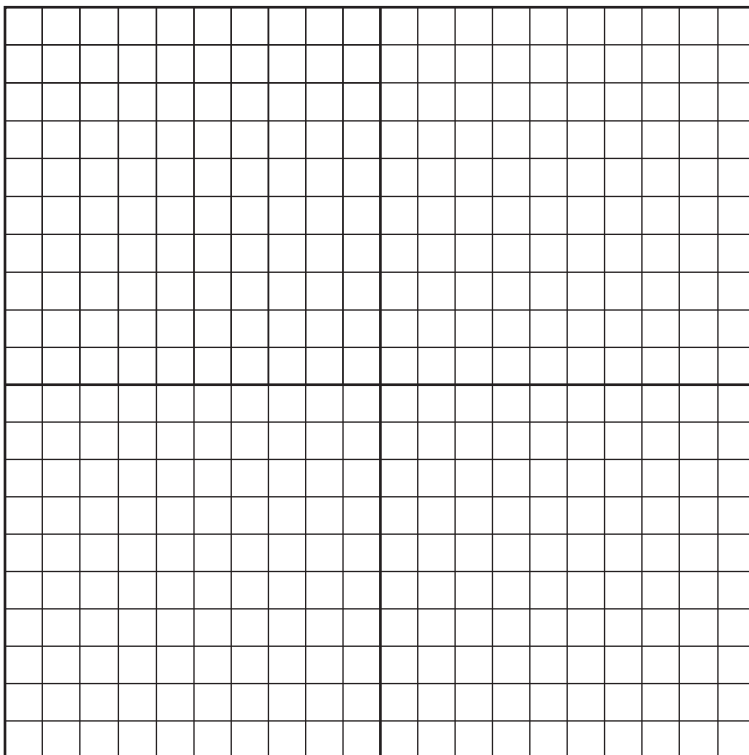

Complete the pattern.

① $22 \times 10^1 = 22 \times 10 =$ _____	② $412 \times 10^1 =$ _____ $= 4,120$
$22 \times 10^2 = 22 \times 100 =$ _____	$412 \times 10^2 = 412 \times 100 =$ _____
$22 \times 10^3 = 22 \times 1,000 =$ _____	$412 \times 10^3 =$ _____ $= 412,000$
$22 \times 10^4 = 22 \times 10,000 =$ _____	$412 \times 10^4 = 412 \times 10,000 =$ _____

③ $56 \times 10^1 =$ _____ $= 560$	④ $8 \times 10^1 = 8 \times 10 =$ _____
$56 \times 10^2 =$ _____ $= 5,600$	$8 \times 10^2 = 8 \times 100 =$ _____
$56 \times 10^3 =$ _____ $= 56,000$	$8 \times 10^3 = 8 \times 1,000 =$ _____
$56 \times 10^4 =$ _____ $= 560,000$	$8 \times 10^4 = 8 \times 10,000 =$ _____

Draw a shape that fits the description. Mark all congruent segments and right angles.

- |                                                                 |                                              |
|-----------------------------------------------------------------|----------------------------------------------|
| ⑤ a triangle with a right angle and exactly two congruent sides | ⑥ a concave octagon with all sides congruent |
|-----------------------------------------------------------------|----------------------------------------------|

- ⑦ **Stretch Your Thinking** List the dimensions of two different rectangular prisms in which each has a volume of 6,600 cubic centimeters.

---



---